



Ficha técnica do produto

Datasheet / Ficha técnica del producto

Data: 06.01.2021

Versão: 2.0

IN.13.189

Frragens diversas/
General hardware / Herrajes diversas

ET:1721/2016

Documento confidencial / Confidential document / Documento confidencial @ JNF 2021 www.jnf.pt

Descrição / Description / Descripción

Batente de porta com retenção magnética /
Door stopper with magnetic holder /
Tope de puerta magnetico

Versão / Version / Versión

2.0

Data / Date / Data

06.01.2021

Material / Material / Material

Aço Inox / Stainless Steel / Acero inoxidable - EN 1.4301

Acabamento / Finish / Acabado

Satinado / Satin / Satin

Acessórios / Accessories / Accesorios

1x- Chave allen / Allen key / Llave allen - 4mm

1x- Bucha de nylon / Nylon plug / Tarugo de nylon

1x- Bucha metálica / Metallic plug / Tarugo metalico

1x- Parafuso / Screw / Tornillo - Ø4x40mm

1x- Parafuso / Screw / Tornillo - DIN 914 M6x30mm

1x- Parafuso / Screw / Tornillo - M10x12mm (M6 interior)

Info. Embalagem / Package / Embalage

Código de barras/
Bar code/
Código de barras



5 1602686 1034048



5 1602686 1534043

Unidade/ Unit/ Unidad

1 Un.

60 Un.

Peso/ Weight/ Peso

0,315 kg

18,900 kg

Medidas/ Dimensions/ Dimensiones

75 x 65 x 40 mm

280 x 220 x 245 mm

Embalagem/ Package/ Embalage

CA320

Cartão / Carton





Ficha técnica do produto

Datasheet / Ficha técnica del producto

Data: 06.01.2021

Versão: 2.0

IN.13.189

Frragens diversas/
General hardware / Herrajes diversas

ET:1721/2016

Documento confidencial / Confidential document / Documento confidencial @ JNF 2021 www.jnf.pt

Descrição / Description / Descripción

Batente de porta com retenção magnética /
Door stopper with magnetic holder /
Tope de puerta magnetico

Versão / Version / Versión

2.0

Data / Date / Data

06.01.2021

Força / Strength / Fuerza

20kg

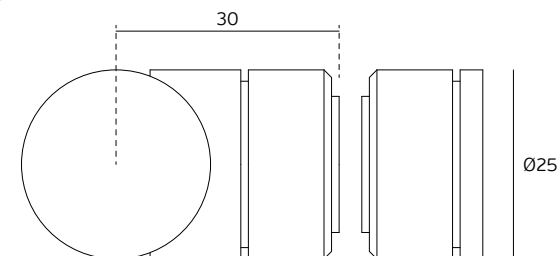

1.

1.1)

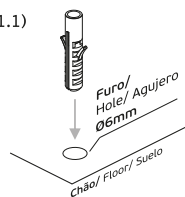

1.2)

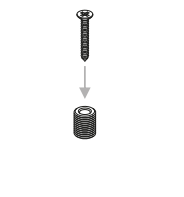

1.3)

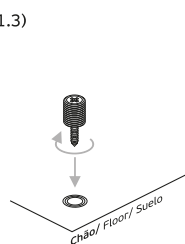

1.4)

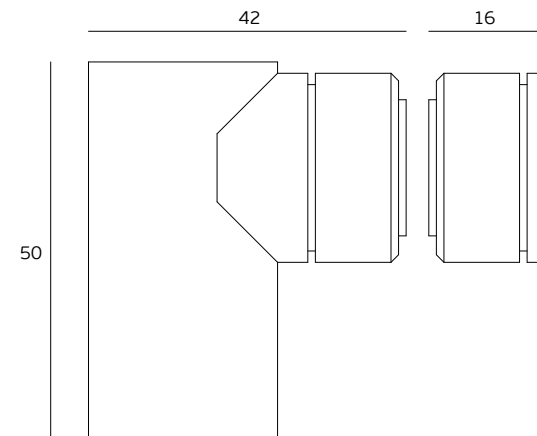
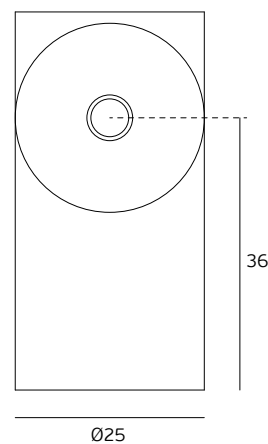
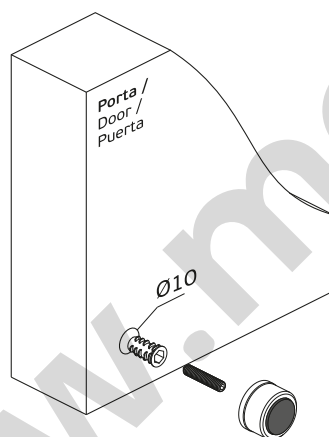
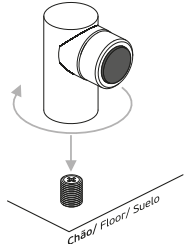

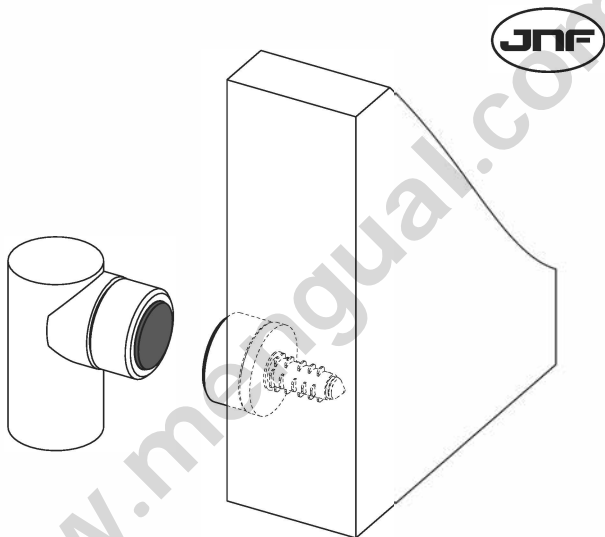

IN.13.189

BATENTE DE PORTA COM RETENTOR MAGNÉTICO /
DOOR STOPPER WITH MAGNETIC HOLDER /
TOPE DE PUERTA CON RETENEDOR MAGNÉTICO

Montagem / Mounting / Montaje

1.

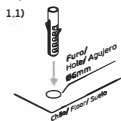

1.2)



1.3)

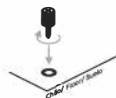

1.4)

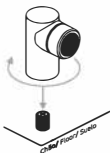

2.

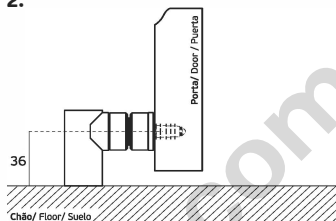

3.

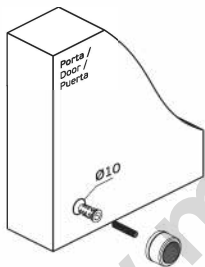

4.

